

SAP DESCRIPTION: **Station Sandstorm 3 x 20"**

SKU No. **71910-006105**

Maximum Flow Rate: 45 m³/h

Recommended Flow Rate: 36 m³/h

Inlet Pressure: **8 Bar**

Sheet Size:
A4

Scale:
1:15

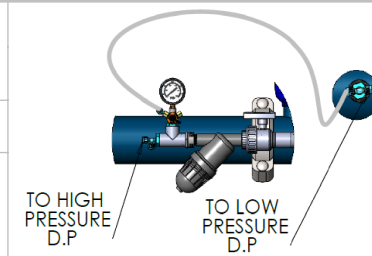

PROPRIETARY AND CONFIDENTIAL
THE INFORMATION CONTAINED IN THIS DRAWING IS THE SOLE PROPERTY OF NETAFIM. ANY REPRODUCTION IN PART OR AS A WHOLE WITHOUT THE WRITTEN PERMISSION OF NETAFIM IS PROHIBITED

Designed By		
Drawn By	KEREM	25/11/2019
Checked By		
QA		
Sheet: 1	Of: 3	Rev. -

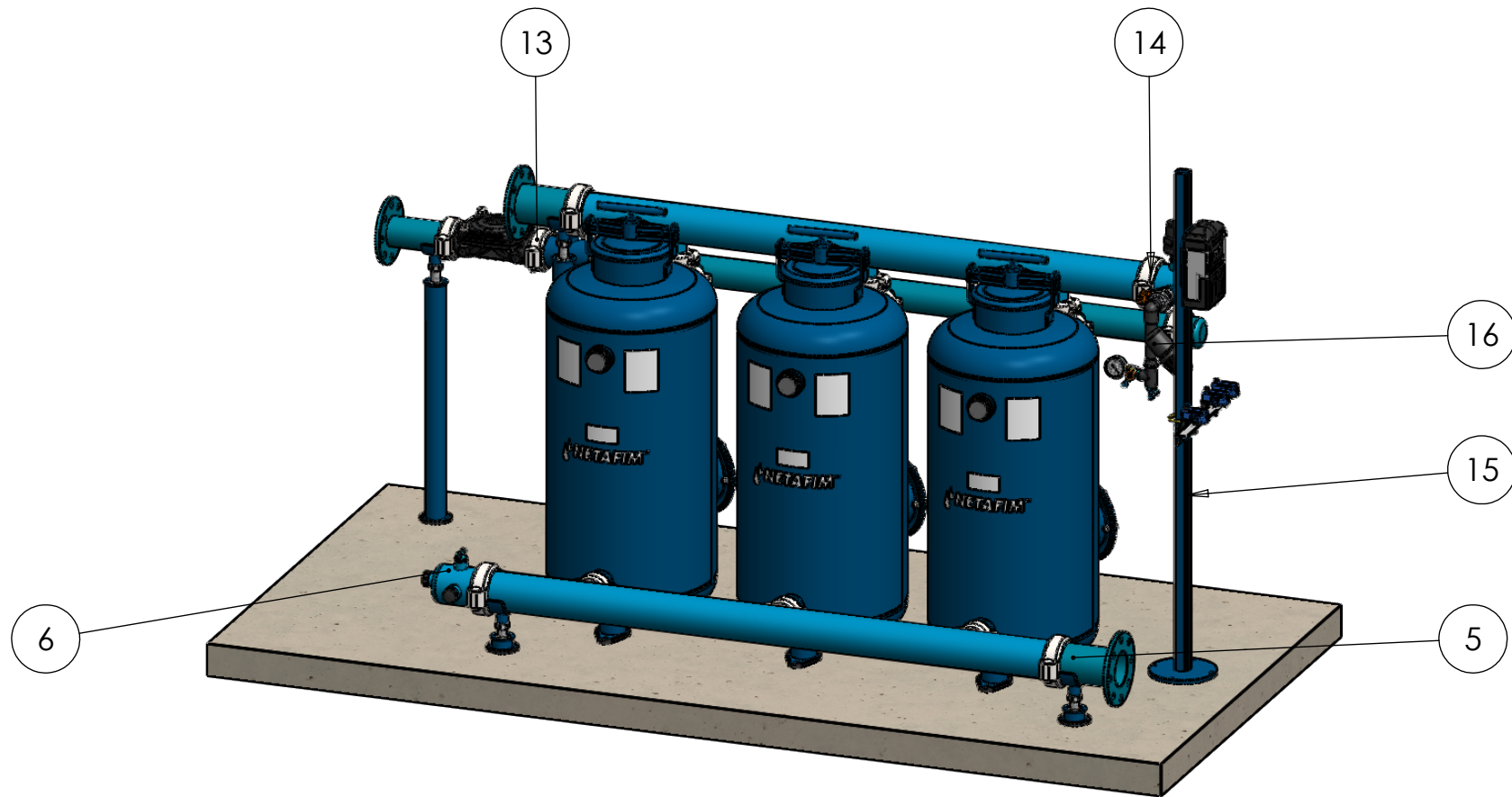

SAP DESCRIPTION: **Station Sandstorm 3 x 20"**

SKU No. **71910-006105**

Maximum Flow Rate: 45 m³/h

Recommended Flow Rate: 36 m³/h

Inlet Pressure: **8 Bar**

Sheet Size:
A4

Scale:
1:20

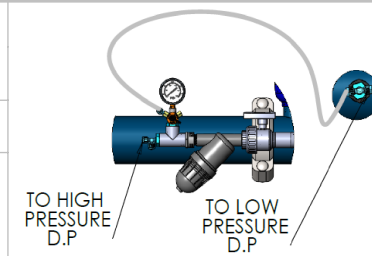

PROPRIETARY AND CONFIDENTIAL
THE INFORMATION CONTAINED IN THIS DRAWING IS THE SOLE PROPERTY OF NETAFIM. ANY REPRODUCTION IN PART OR AS A WHOLE WITHOUT THE WRITTEN PERMISSION OF NETAFIM IS PROHIBITED

Designed By		
Drawn By	KEREM	25/11/2019
Checked By		
QA		
Sheet: 2	Of: 3	Rev. -

ITEM NO.	SAP Description	SAP Cat. No.	QTY.
1	METAL DBL.CHA.PLUS 20"*2" BSP PN08	71910-010034	3
2	METAL MAN 4"*3 OUT*2" VIC F/20" TANK	71910-001717	2
3	METAL BF MAN 3"*3 OUT*2" VIC F/20" TANK	71910-001716	1
4	METAL TRANSITION 3" ISO FLANGE*VIC	71910-002005	1
5	METAL TRANSITION 4" ISO FLANGE*VIC	71910-002008	2
6	MET CUP 4"VIC W/2 OUT 1"BSP+1 OUT 1"BSP	71910-001801	2
7	METAL CUP 3" VIC	71910-001791	1
8	METAL NIPPLE 3"*200MM VIC/VIC+(3/4" BSP)	71910-008980	1
9	D 52 B.F. F/GRV 2*2 ANG.FLO.BSP/2 ADPTR.	71600-006515	3
10	S100CI 3" FCV+ORIFICE 20"-36"	71600-003417	1
11	GALVA. SHORT NIPPLE 2	78200-016500	3
12	VICTAULIC COUPLING 2" ONE BOLT	71910-002500	9
13	VICTAULIC COUPLING 3" ONE BOLT	71910-002501	4
14	VICTAULIC COUPLING 4" ONE BOLT	71910-002502	4
15	Control Stand	71910-000100	1
16	CONTROL KIT FOR MEDIA FILTER - BSP	37090-009600	1
17	AQUATIVE BRACKET DC 3 SOL-CONF.2	35500-000711	1
18	BARAK 1" PP DG-10 PN10 NFR	70500-000630	1
19	SUPPORT LEG 4"-100MM	71910-001899	2
20	SUPPORT LEG 4"-1000MM	71910-001906	1
21	SUPPORT LEG 3"-800MM	71910-001890	2
22	FLUSHING CONTR. DC 6 OUT.+DP SENS.	73240-003179	1
23	PE 8MM W/1 RED STRIPE - 100M	40000-013000	1
24	ACCESS KIT FOR METAL 20"/24" 4"+3" GASK.	37090-009730	1
25	POWER SUPPLY 100-240VAC/12VDC	73240-007240	1

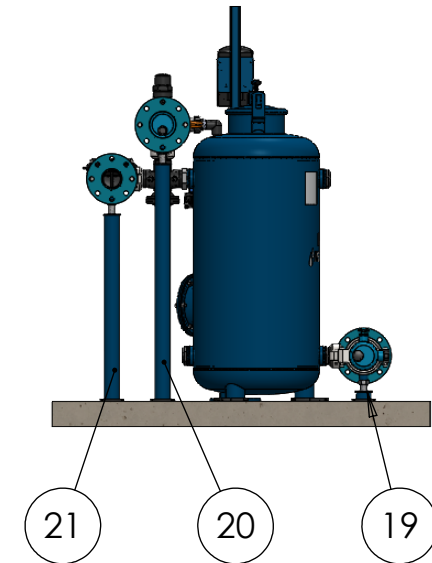
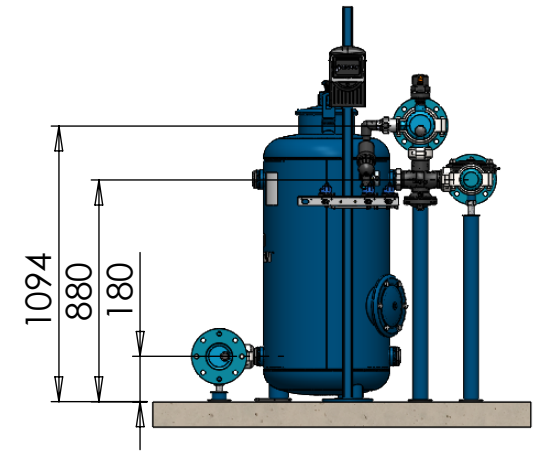

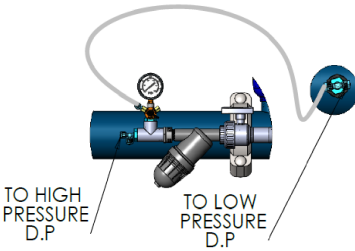
SAP DESCRIPTION: Station Sandstorm 3 x 20"		 <p>NETAFIM™</p> <p><small>PROPRIETARY AND CONFIDENTIAL THE INFORMATION CONTAINED IN THIS DRAWING IS THE SOLE PROPERTY OF NETAFIM. ANY REPRODUCTION IN PART OR AS A WHOLE WITHOUT THE WRITTEN PERMISSION OF NETAFIM IS PROHIBITED</small></p>
SKU No.	71910-006105	
Maximum Flow Rate:	45 m ³ /h	
Recommended Flow Rate:	36 m ³ /h	
Inlet Pressure:	8 Bar	Designed By
Sheet Size:	A4	Scale:
	1:30	Drawn By
		Checked By
		QA
		Sheet: 3 Of: 3 Rev. -